



DUPONT LIBRARY

NICHOLAS THOMPSON / DECEMBER 9, 2019

ARCH401 / DOUGLAS CRAWFORD

PERSPECTIVE 1

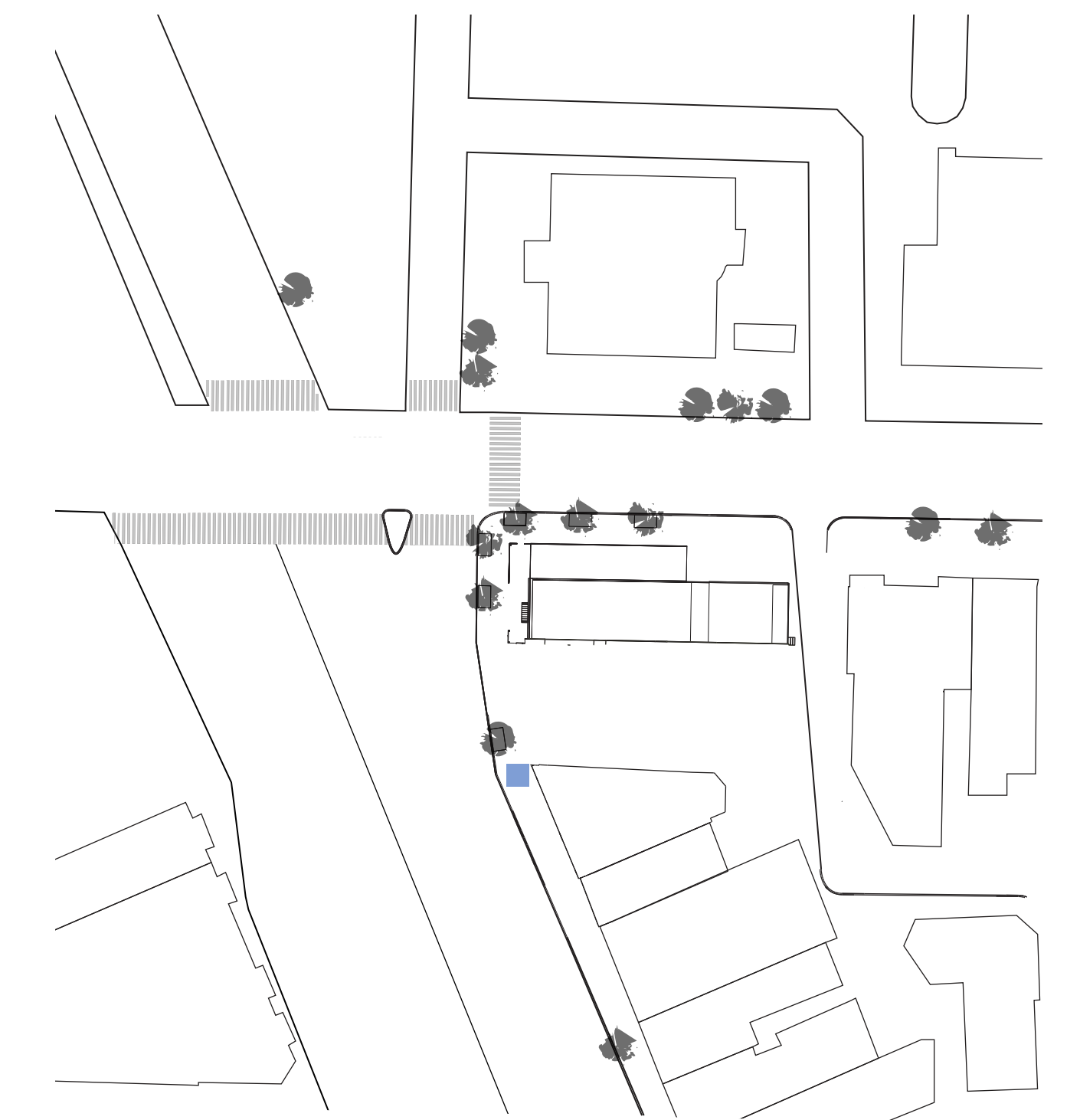

⌚ SITE PLAN

1" = 1/32"

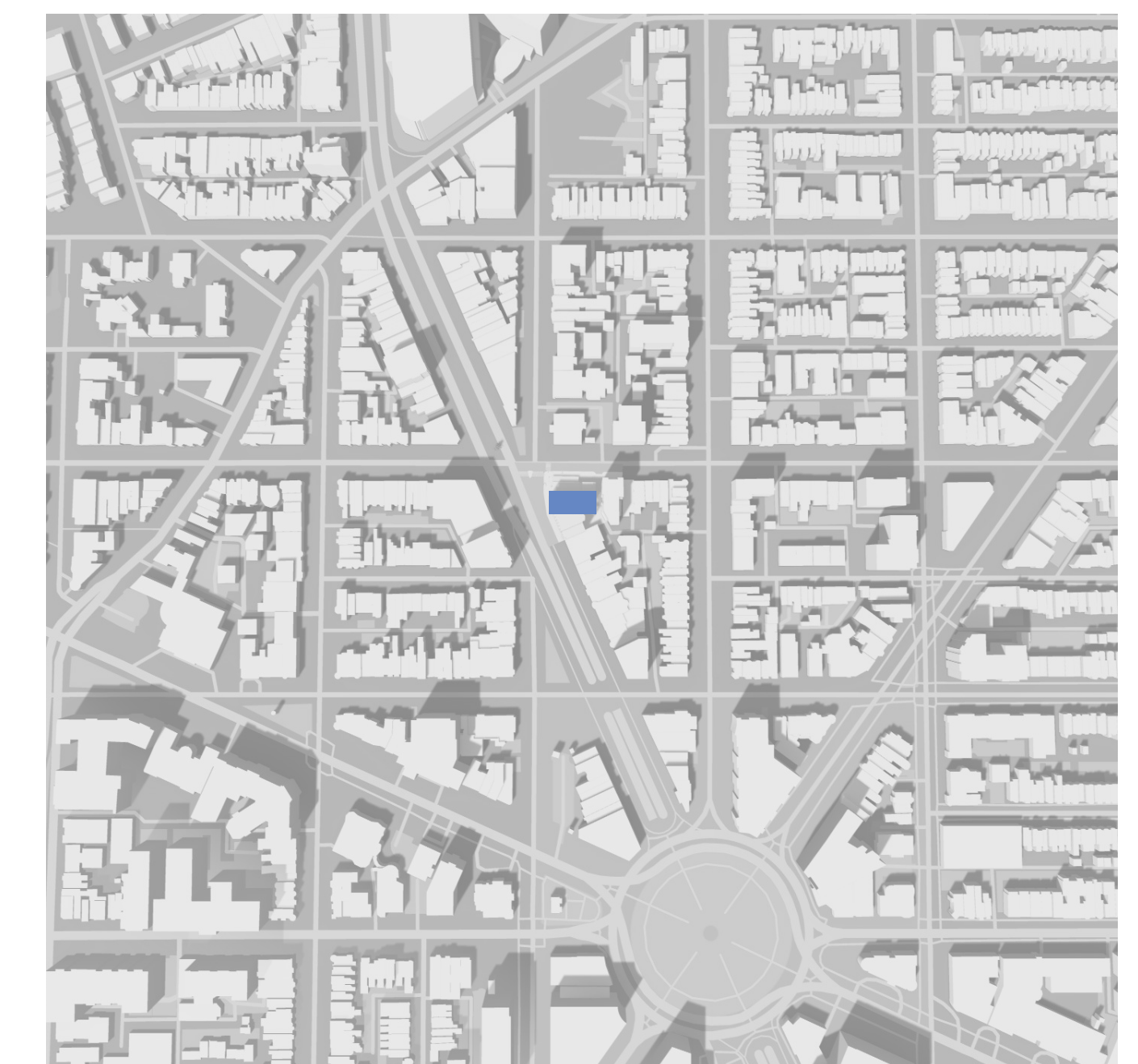

LOCATION MAP



WEST ELEVATION
1' = 1/8"

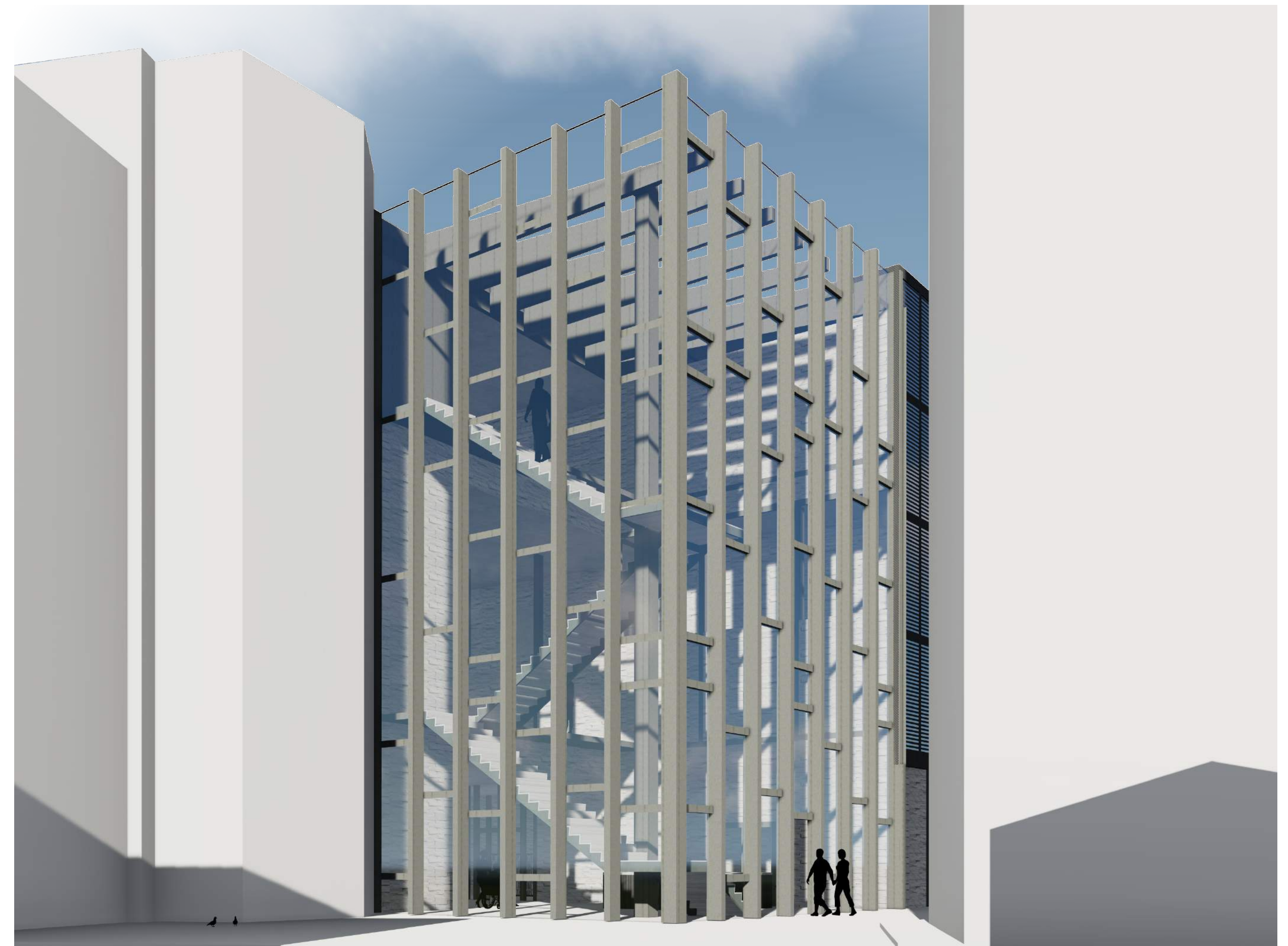

PERSPECTIVE 2

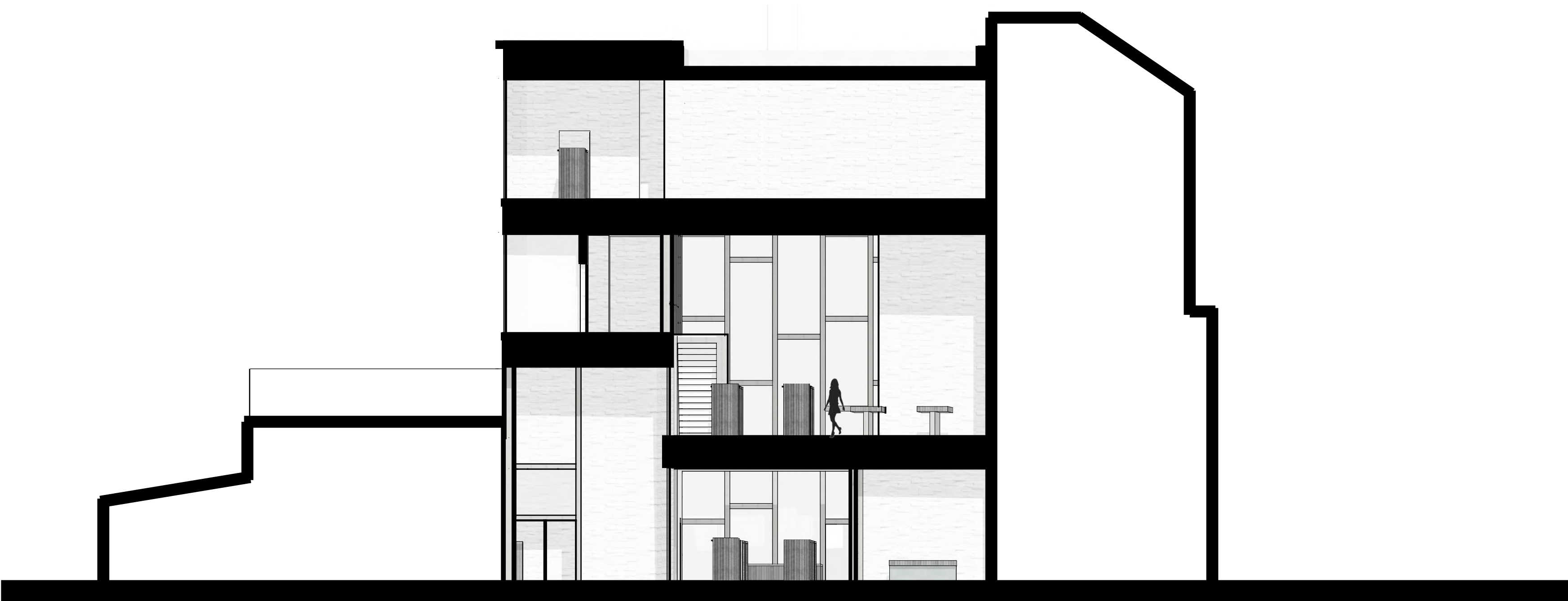

SECTION 1
1' = 1/8"



PERSPECTIVE 3

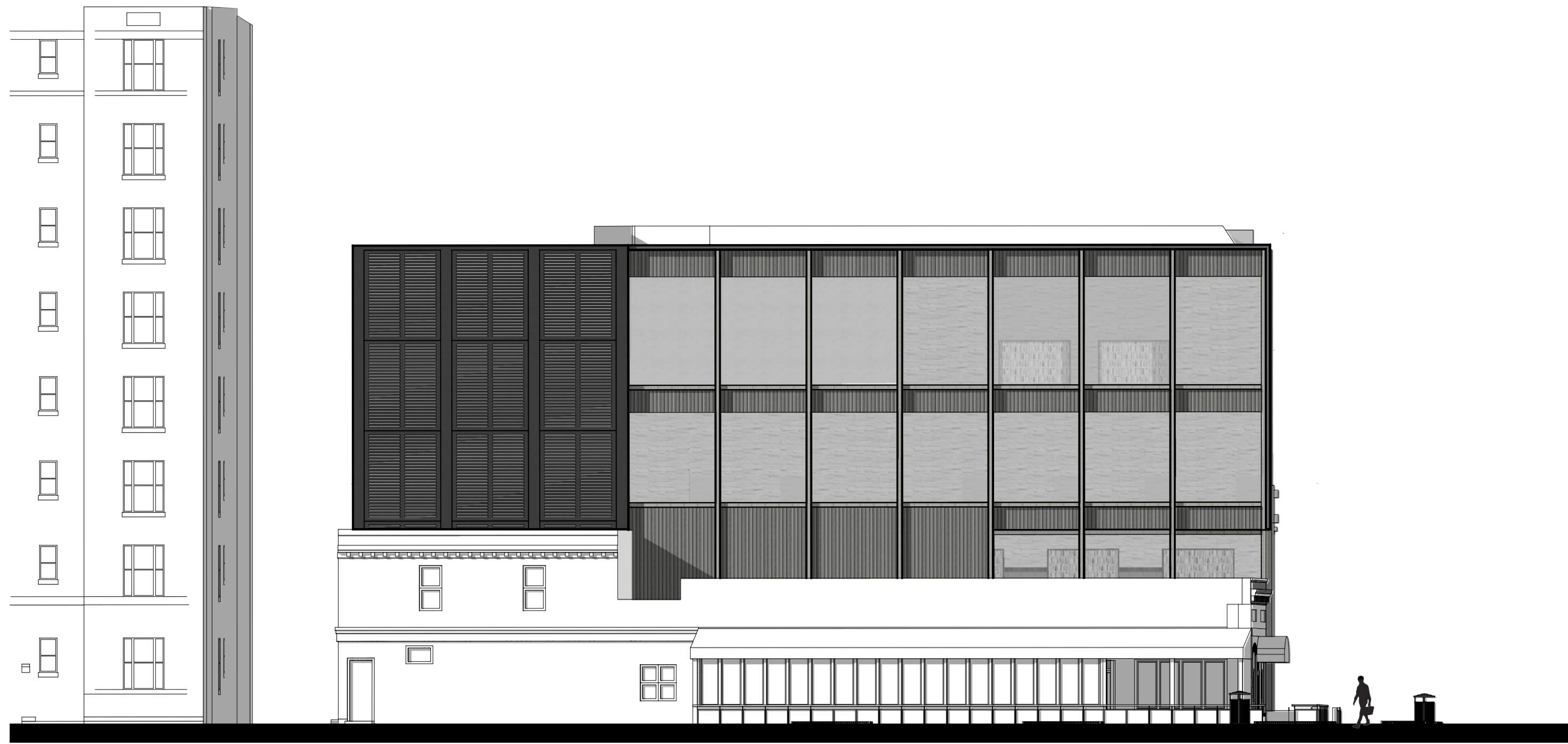

NORTH ELEVATION

1' = 1/8"

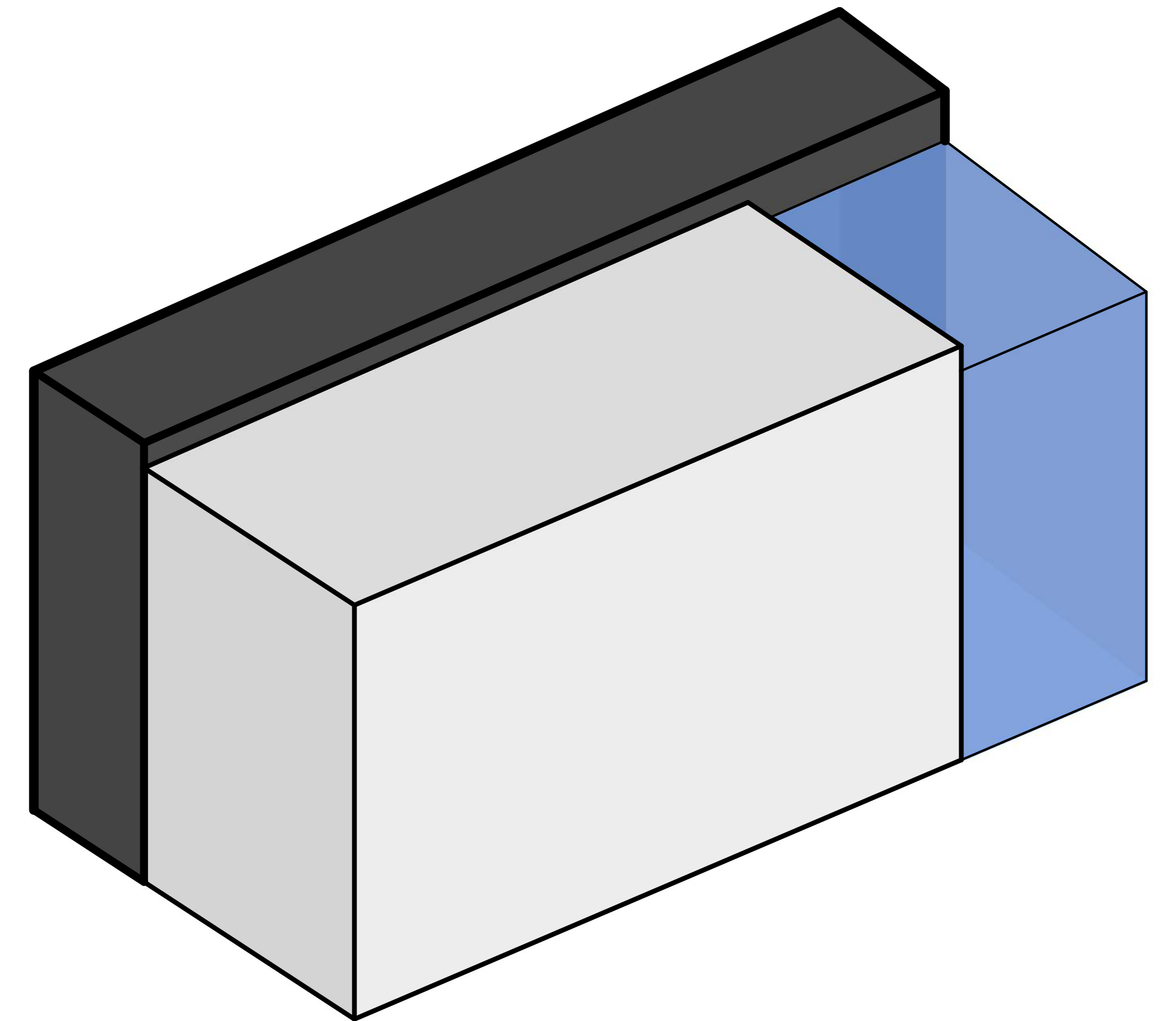

PART I

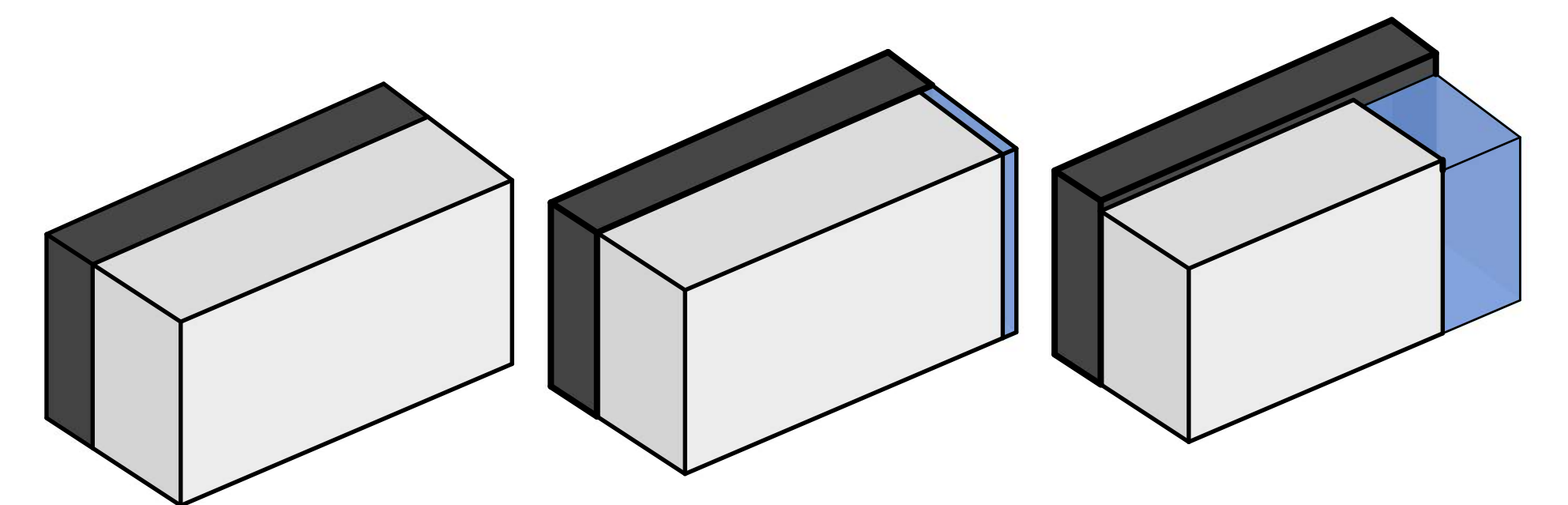

PROCESS DIAGRAM

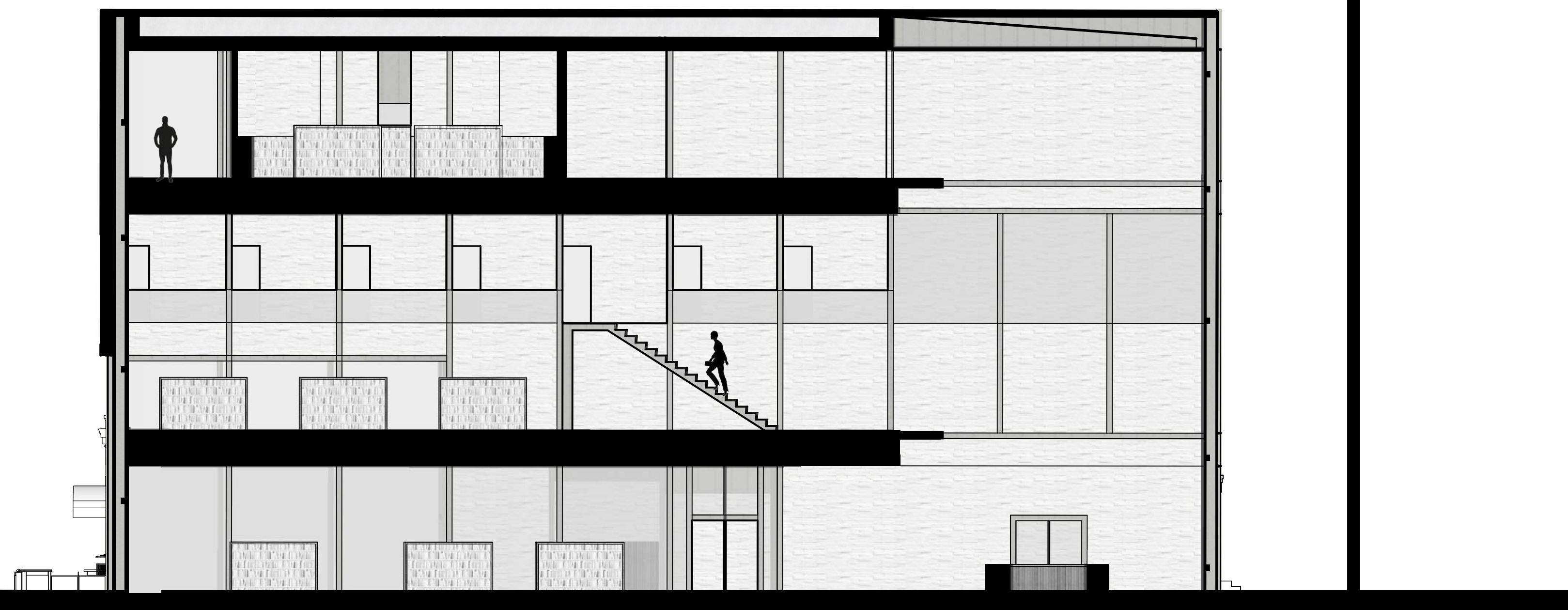

SECTION 2

1' = 1/8"

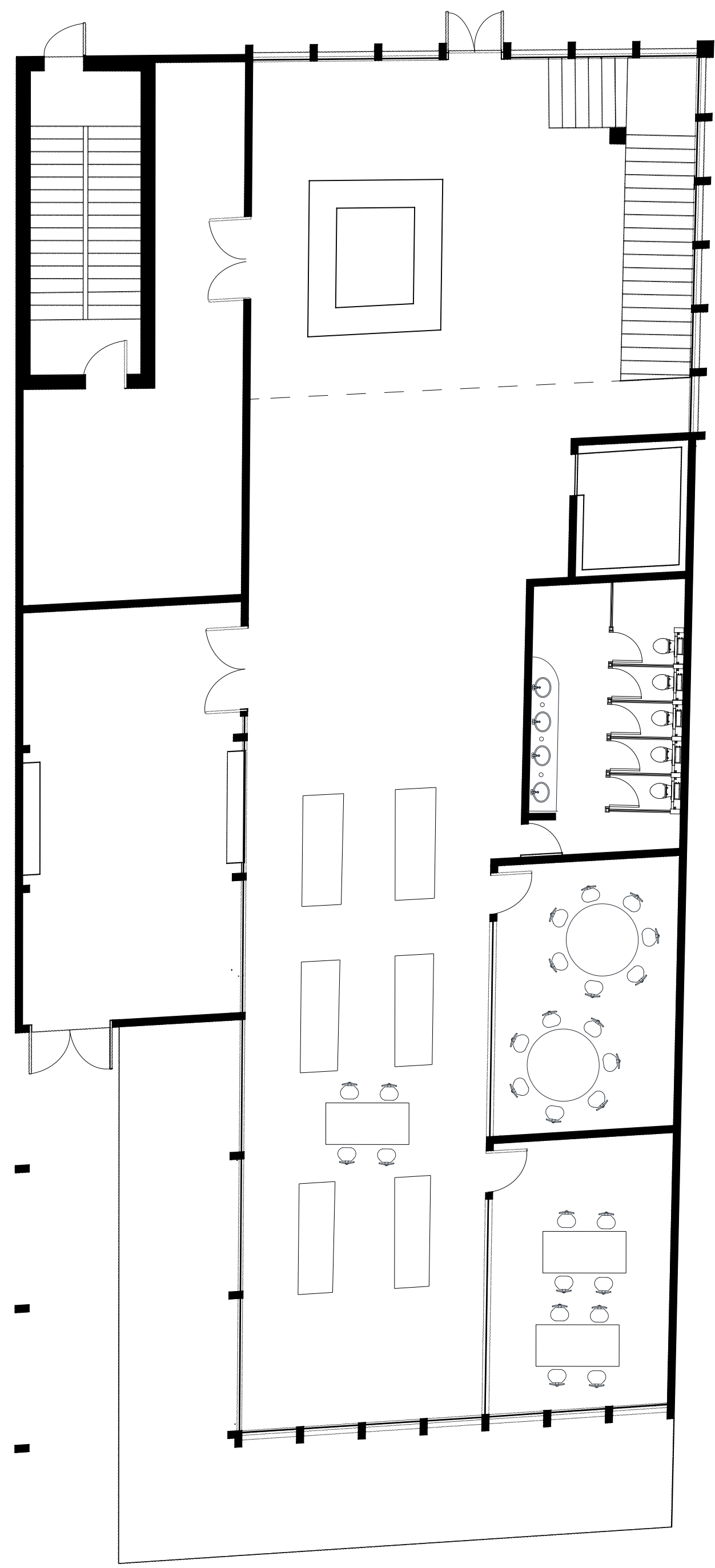

FLOOR 1 PLAN

1' = 1/8"

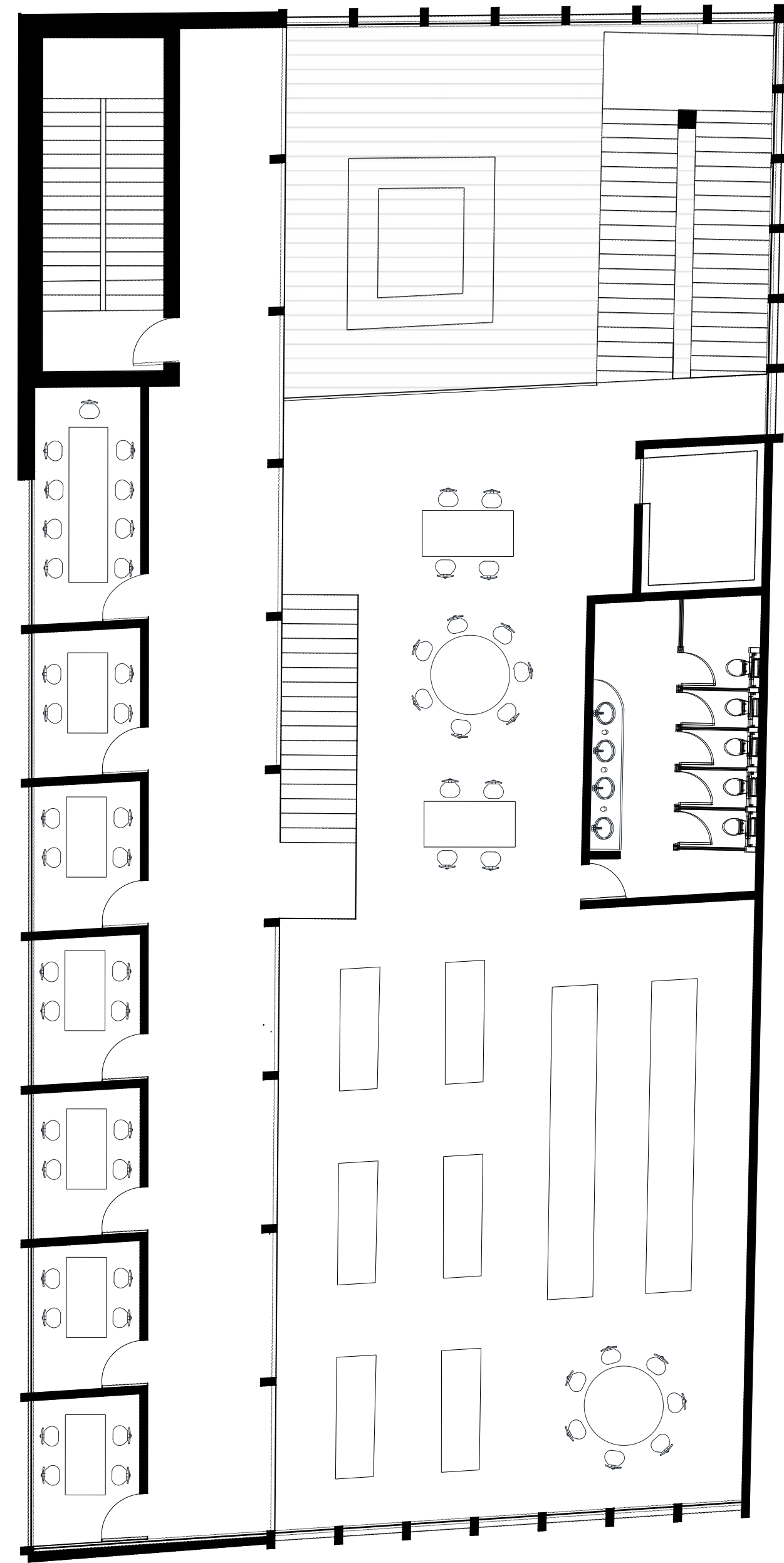

FLOOR 2 PLAN

1' = 1/8"

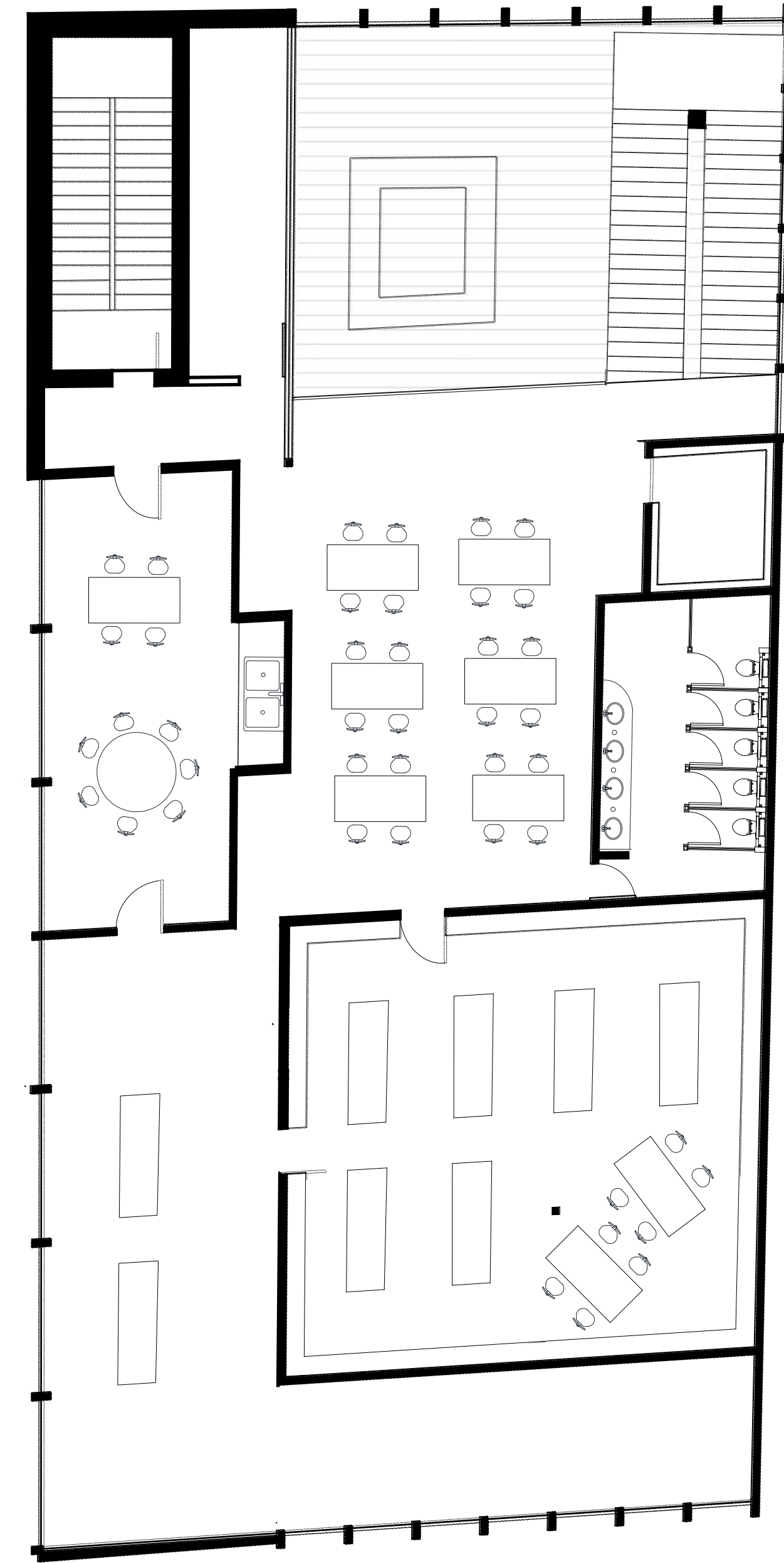

FLOOR 3 PLAN

1' = 1/8"

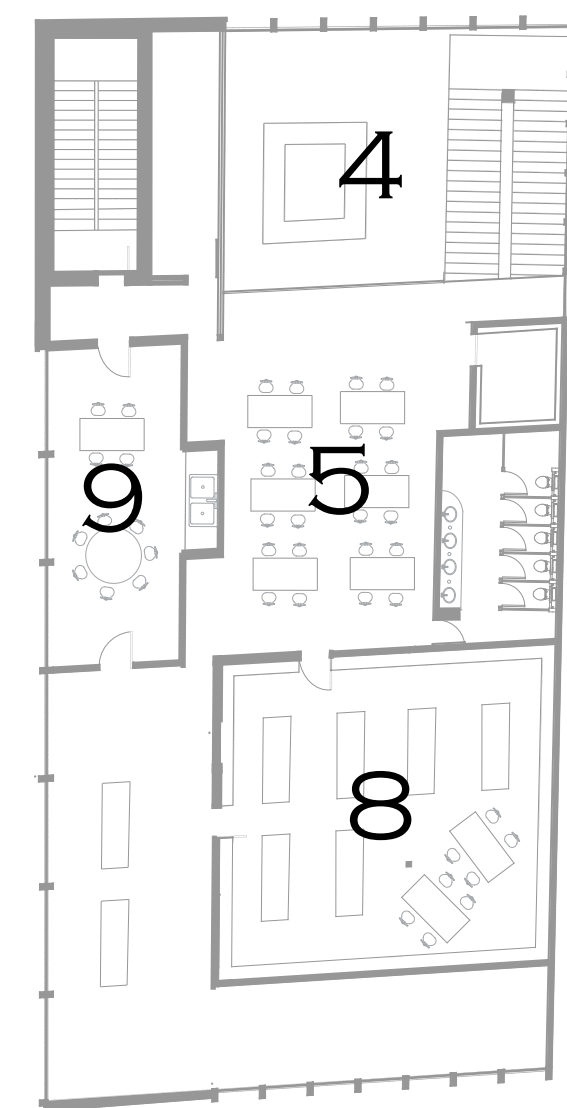
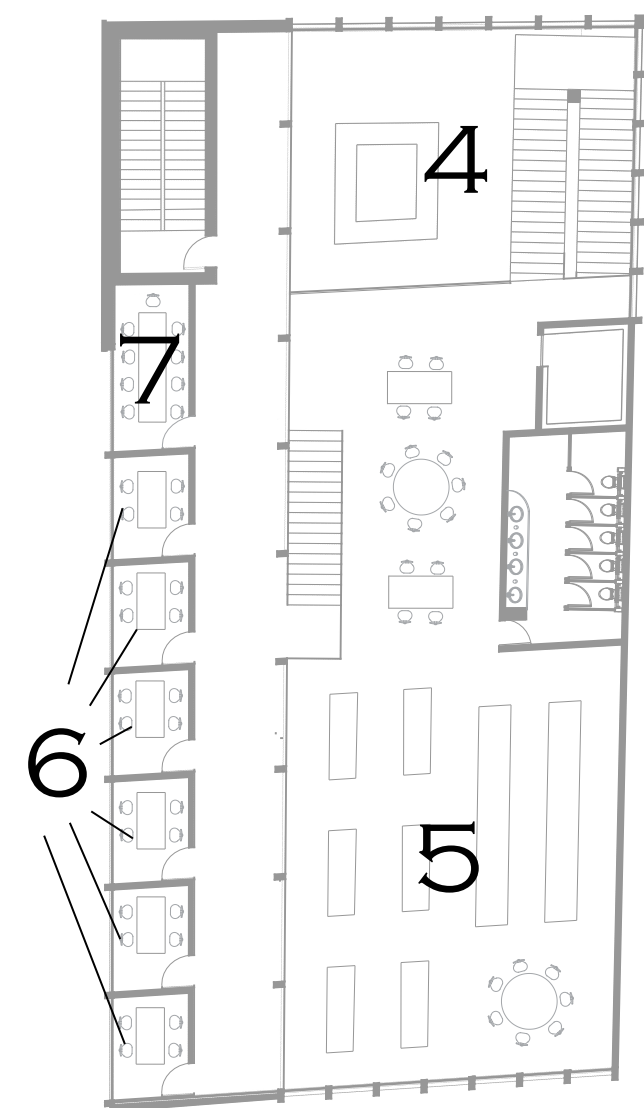
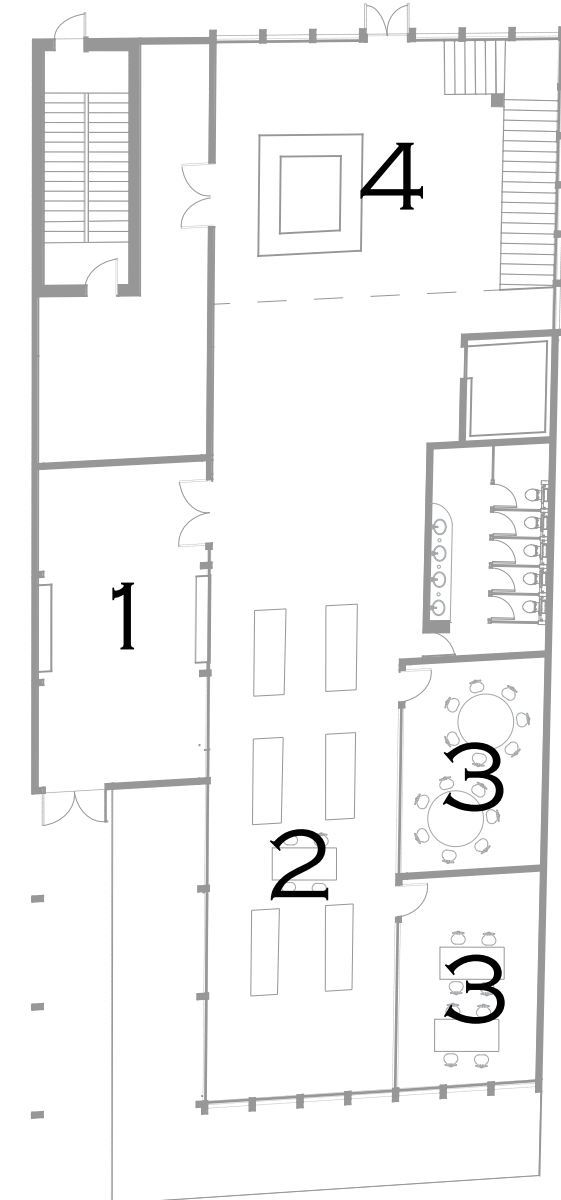

- 1- ENTRANCES
- 2- CHILDRENS AREA
- 3- CLASSROOMS
- 4- ATRIUM/STAIR
- 5- LIBRARY FLOORS
- 6- PRIVATE READING ROOMS
- 7- CONFERENCE ROOM
- 8- SPECIAL COLLECTIONS
- 9- WORKERS AREA

PRIMARY

SECONDARY

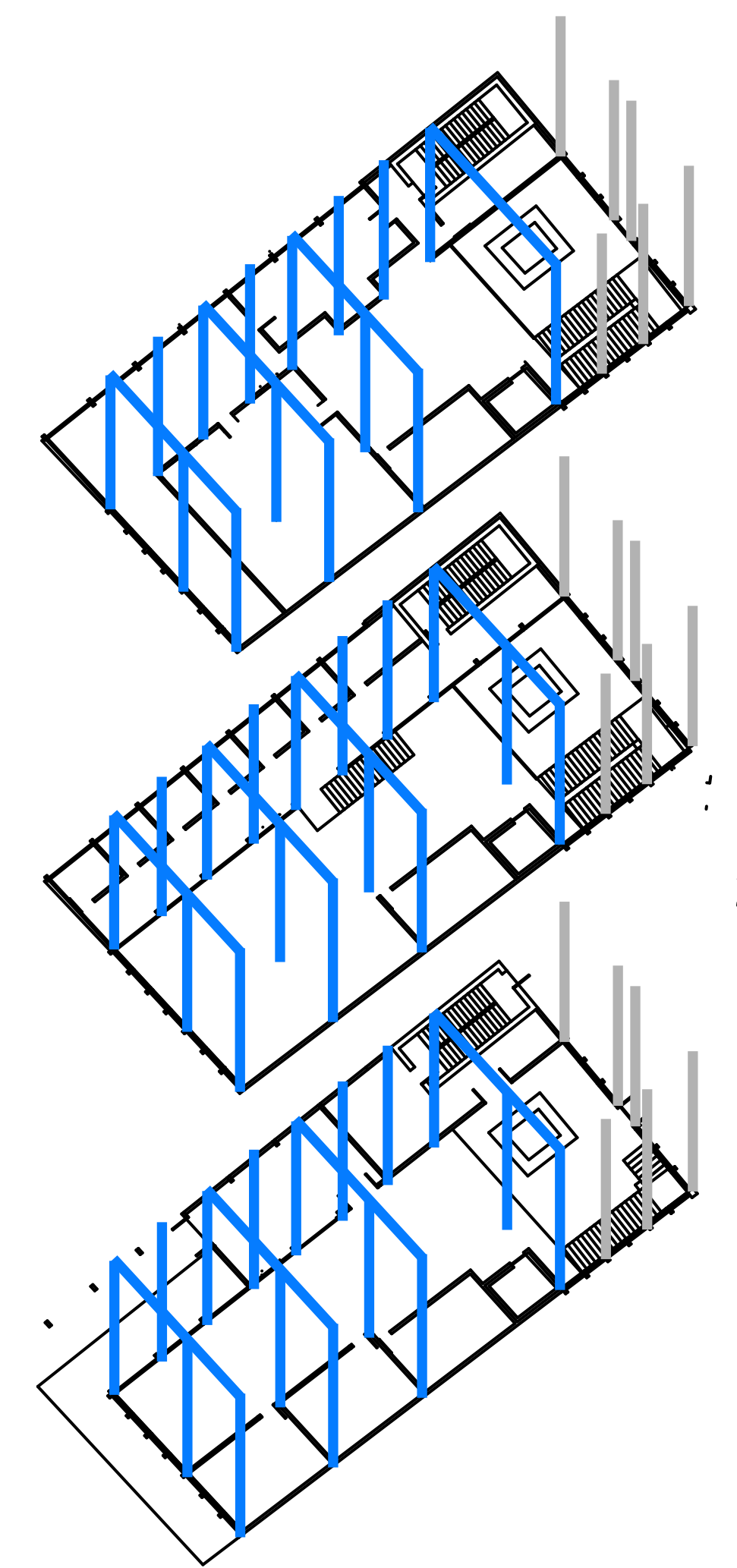

STRUCTURES

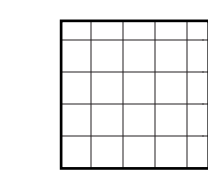
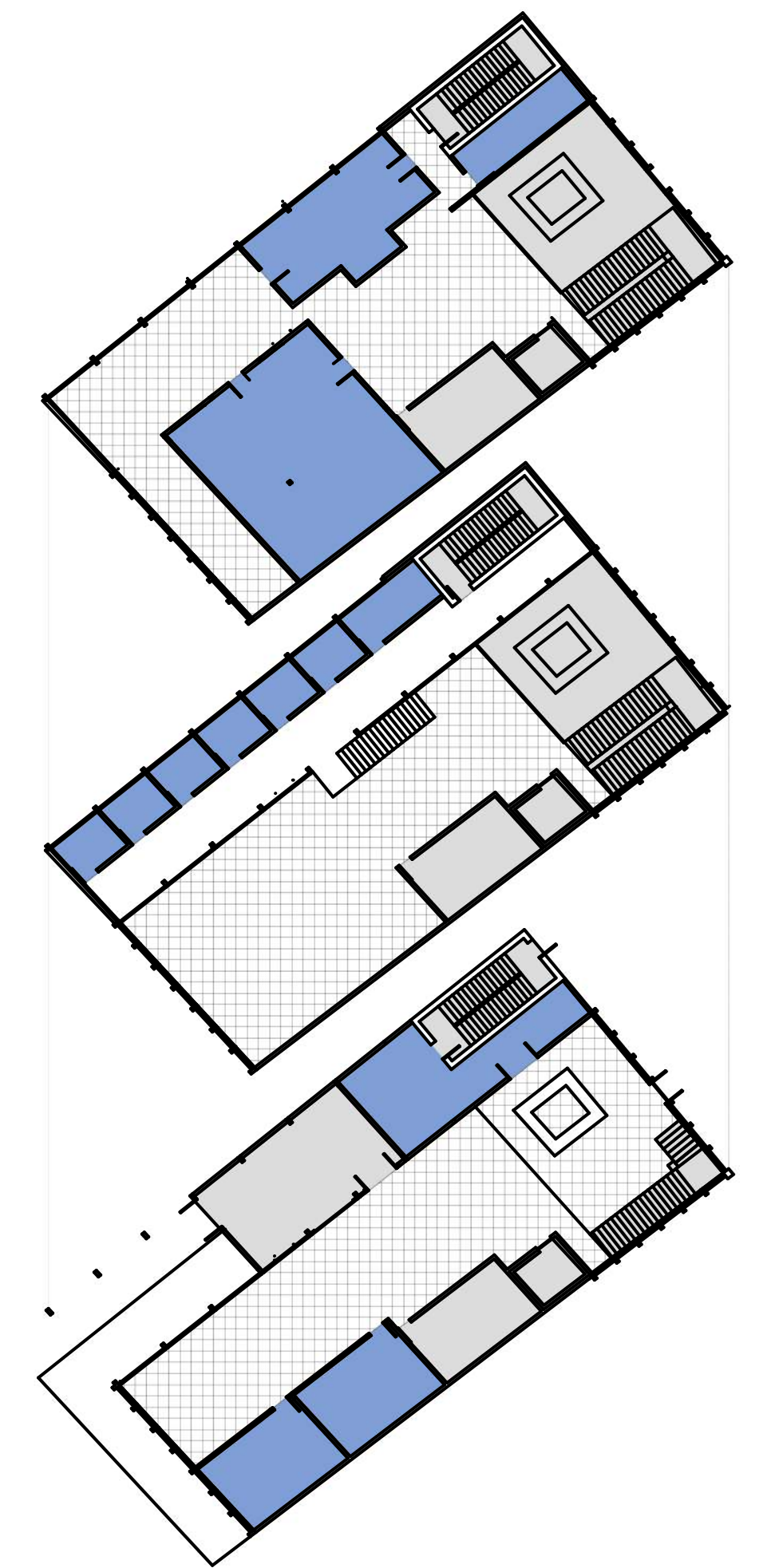

PUBLIC

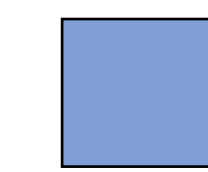

PRIVATE

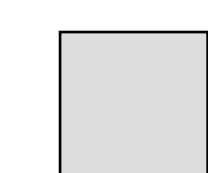

TERTIARY

PUBLIC VS PRIVATE