

BiUS

Baltimore Institute
for Urban
Sustainability

Dylan Blye

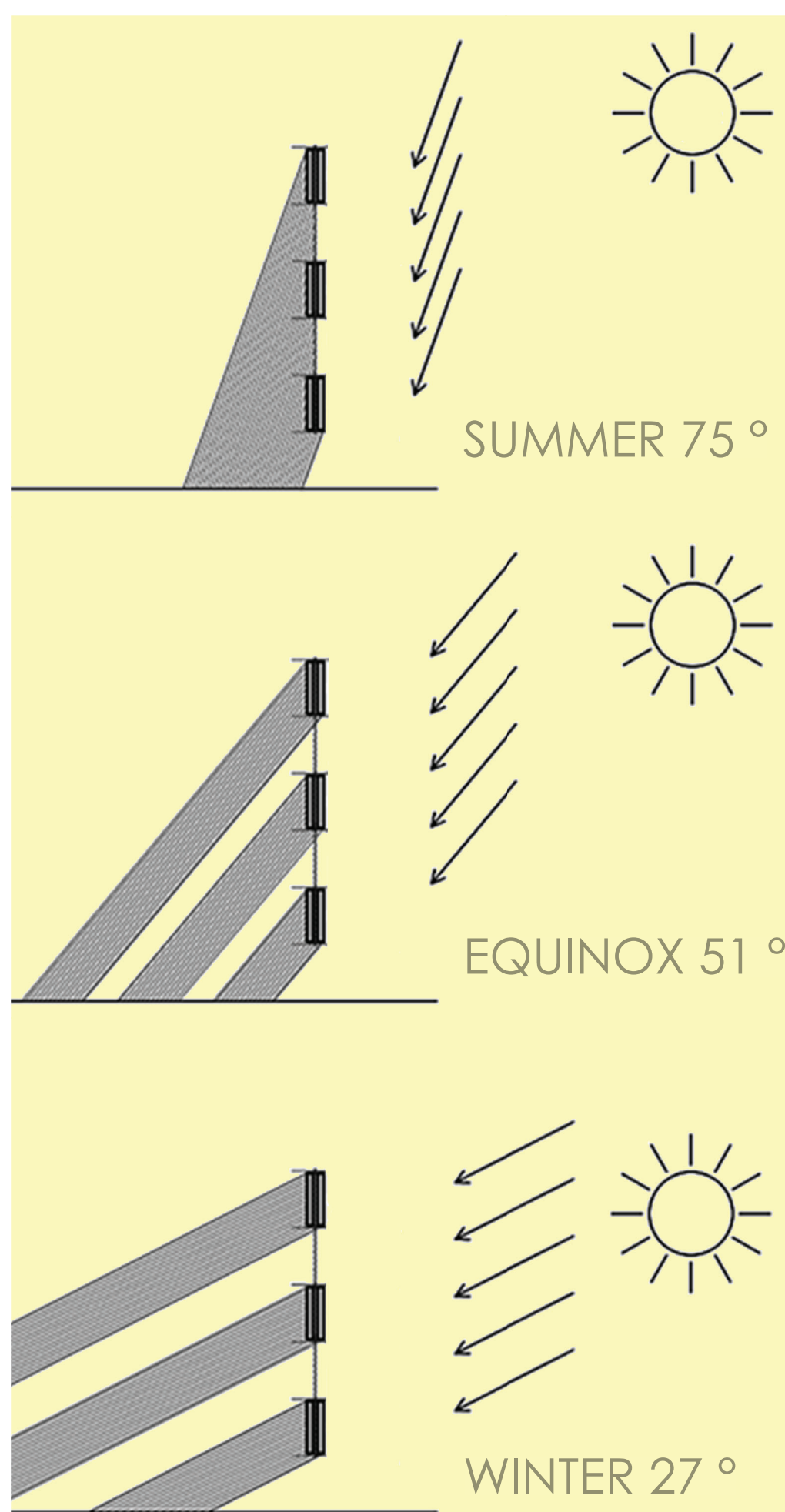

SHADING DEVICES



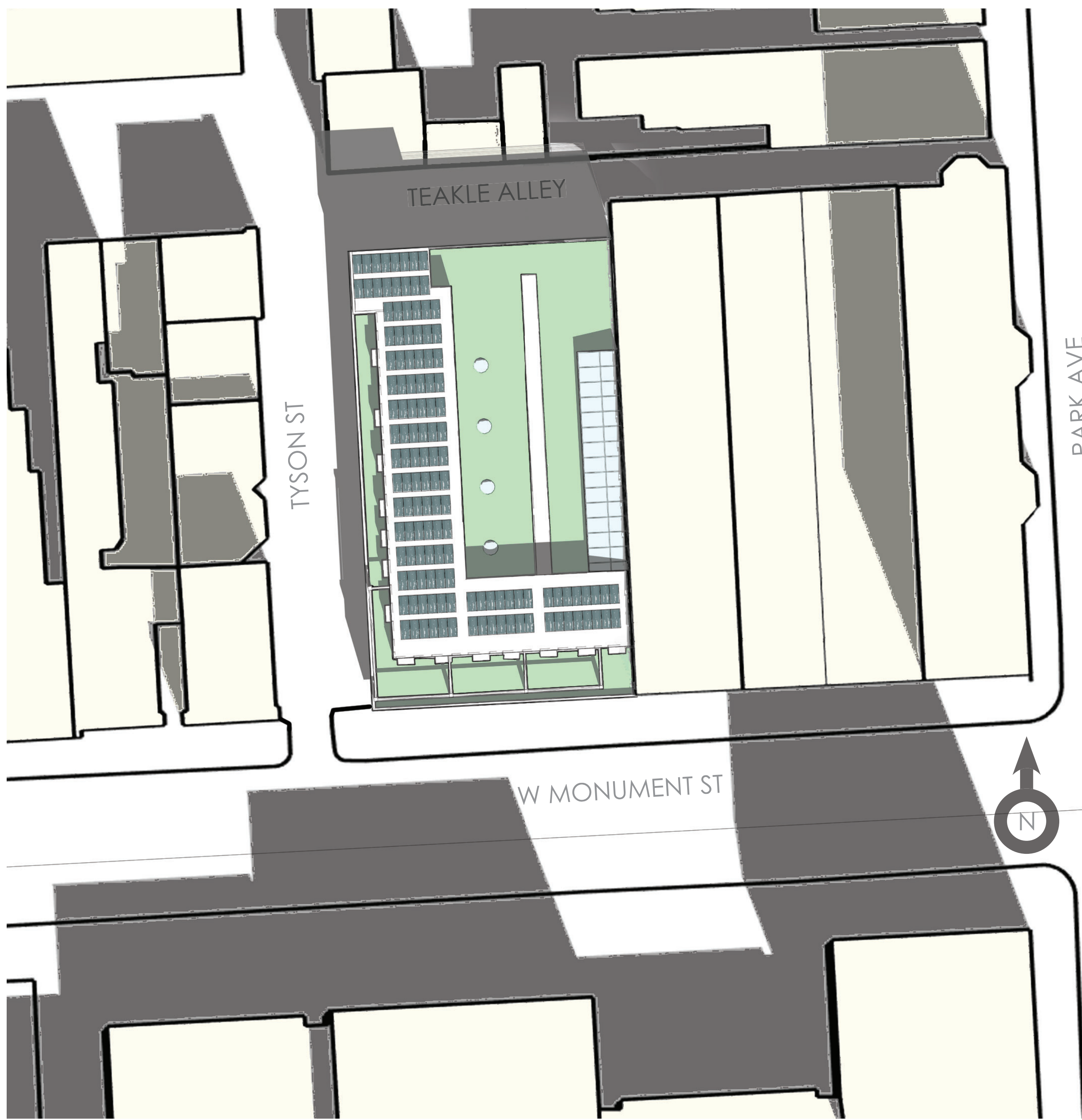

SITE PLAN : 1/16" = 1'-0"

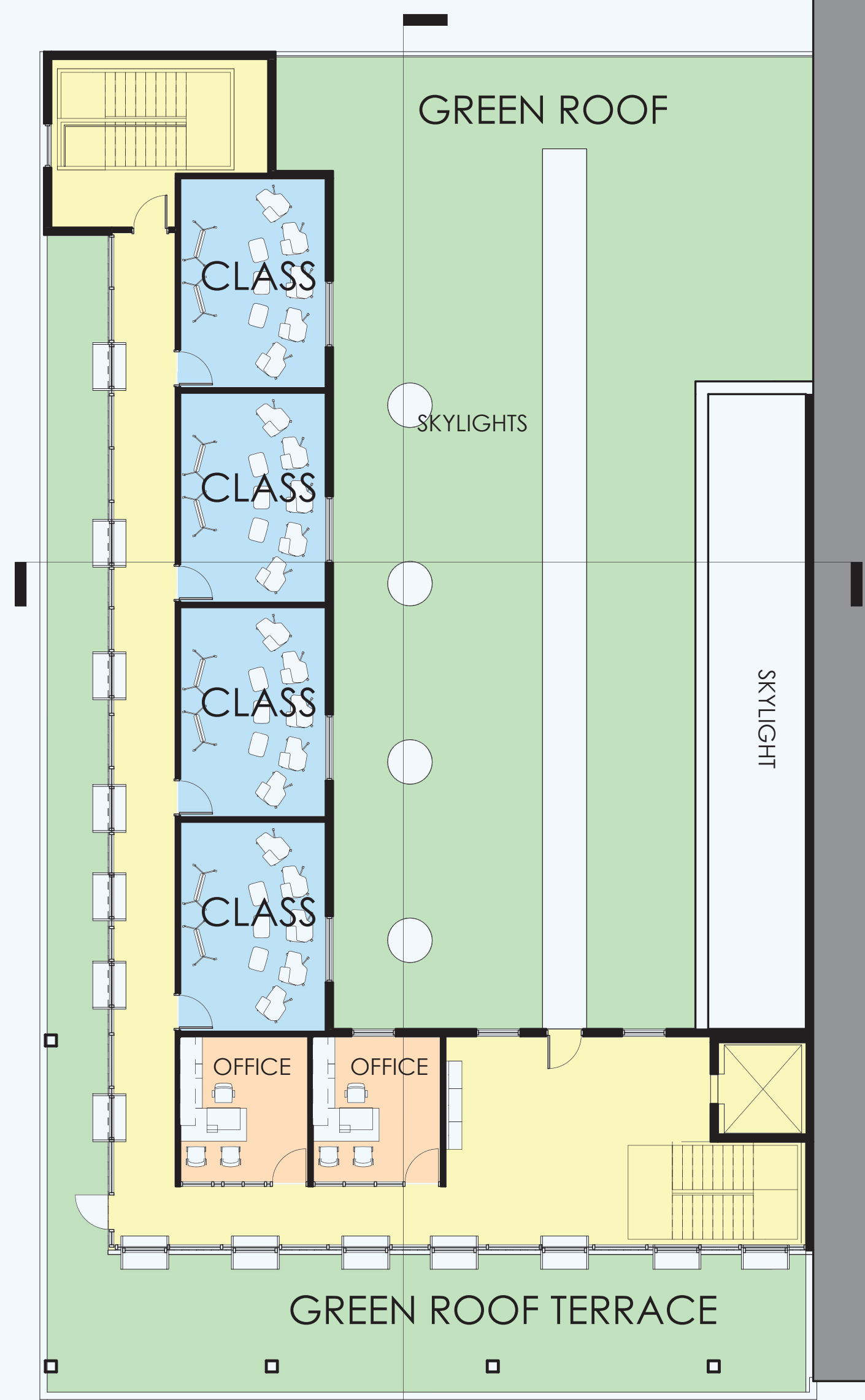

LEVEL 3 : 1/8" = 1'-0"

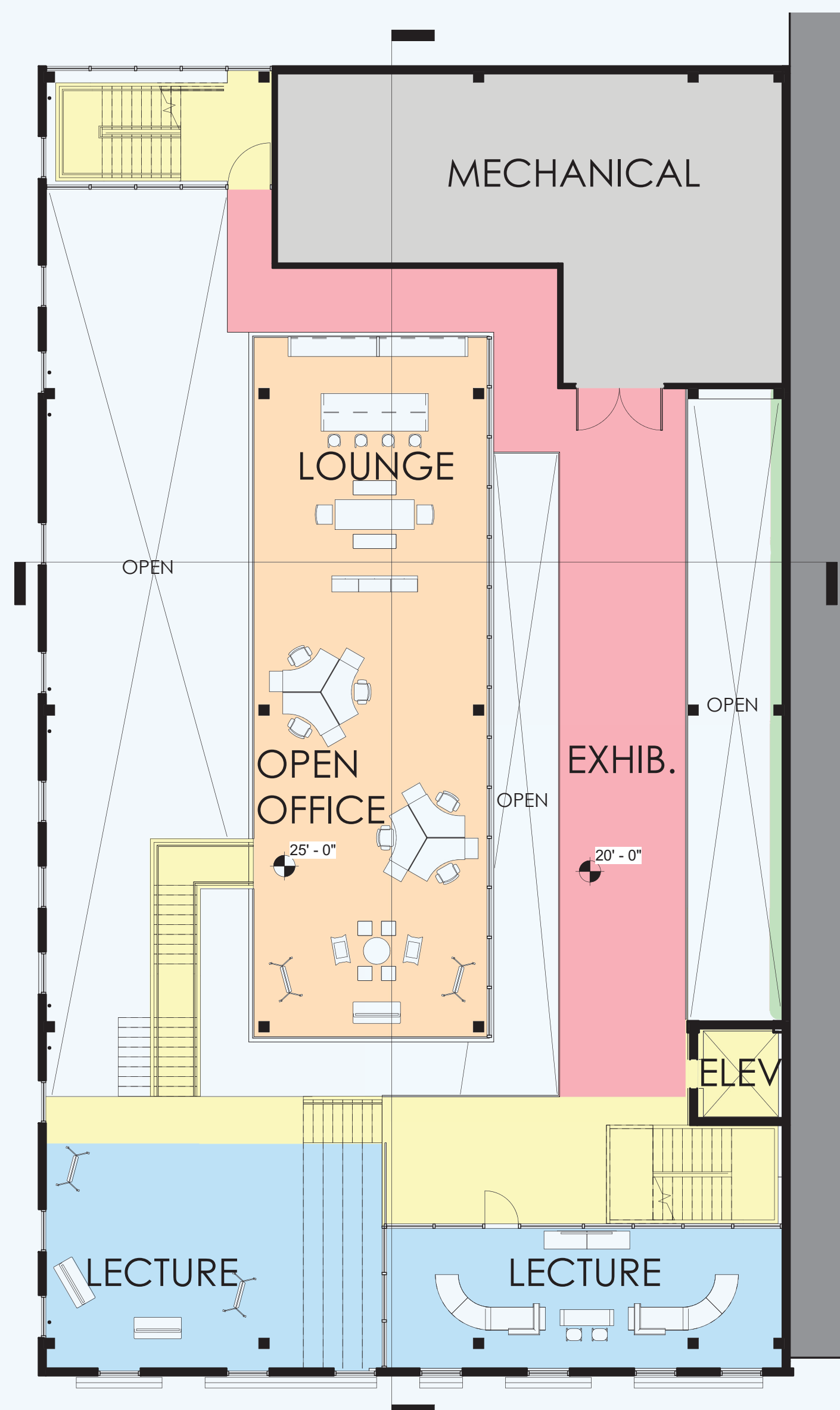

LEVEL 2.2 : 1/8" = 1'-0"

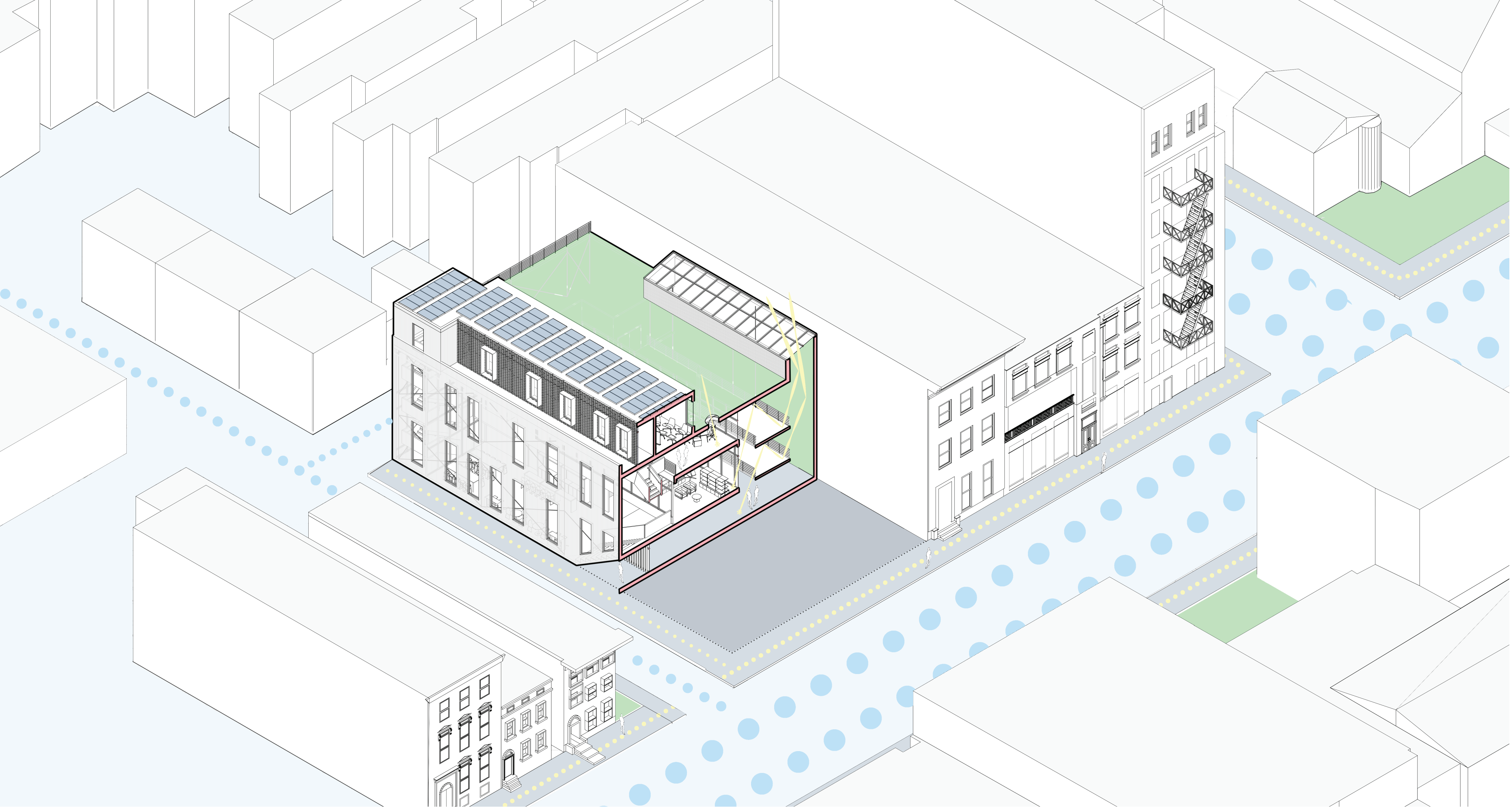

SUSTAINABLE STRATEGIES : 1/16" = 1'-0"



RENEWABLE MATERIALS

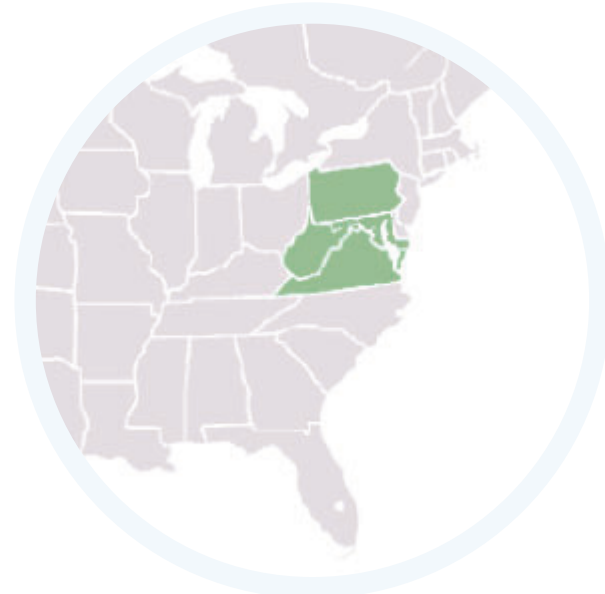

LOCALLY SOURCED



RESILIENT



ENERGY SOURCE



WEST ELEVATION : 1/8" = 1'-0"

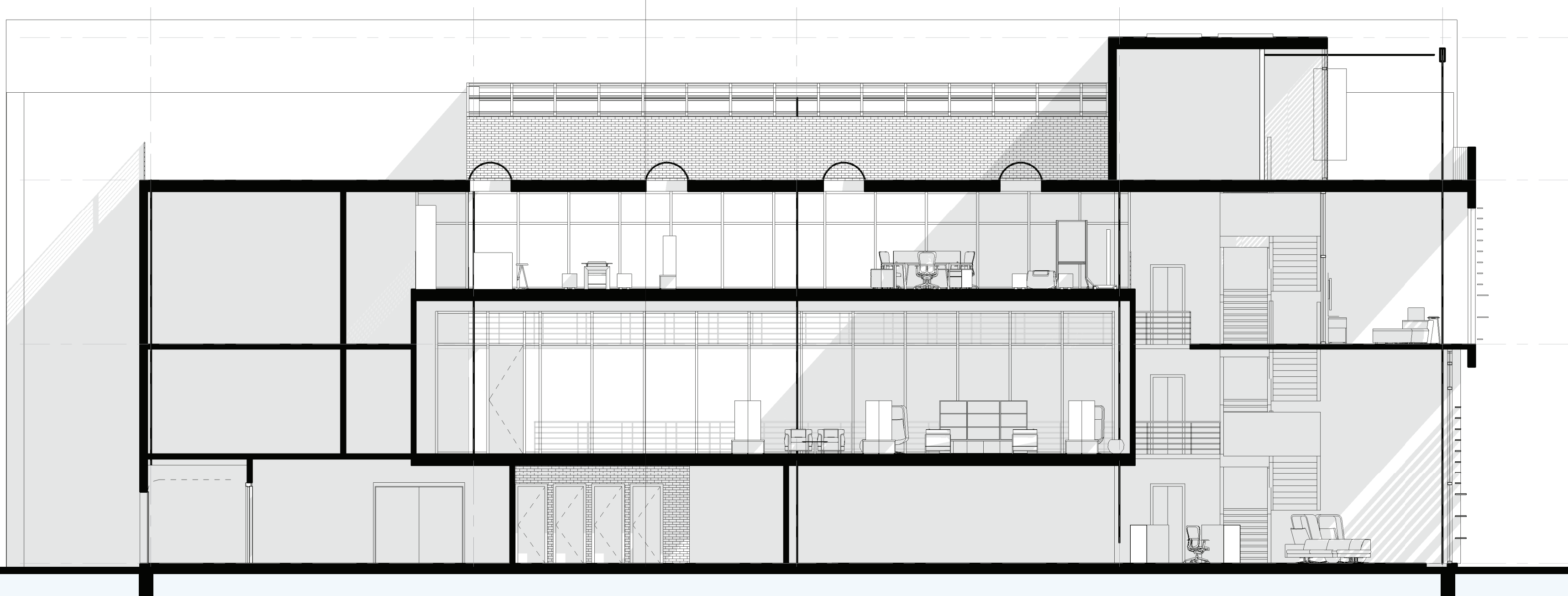

LONGITUDINAL SECTION : 1/8" = 1'-0"

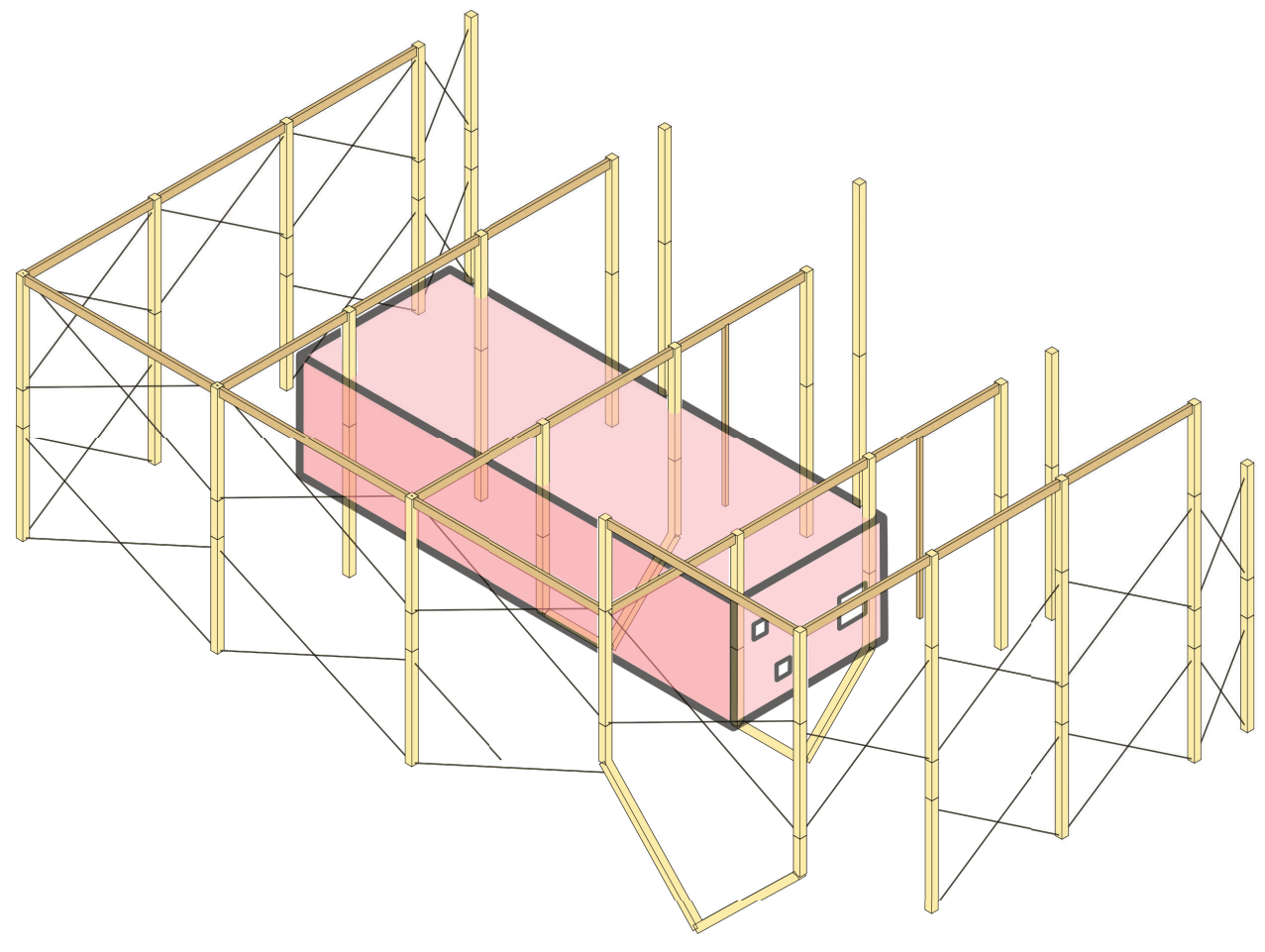

STRUCTURE

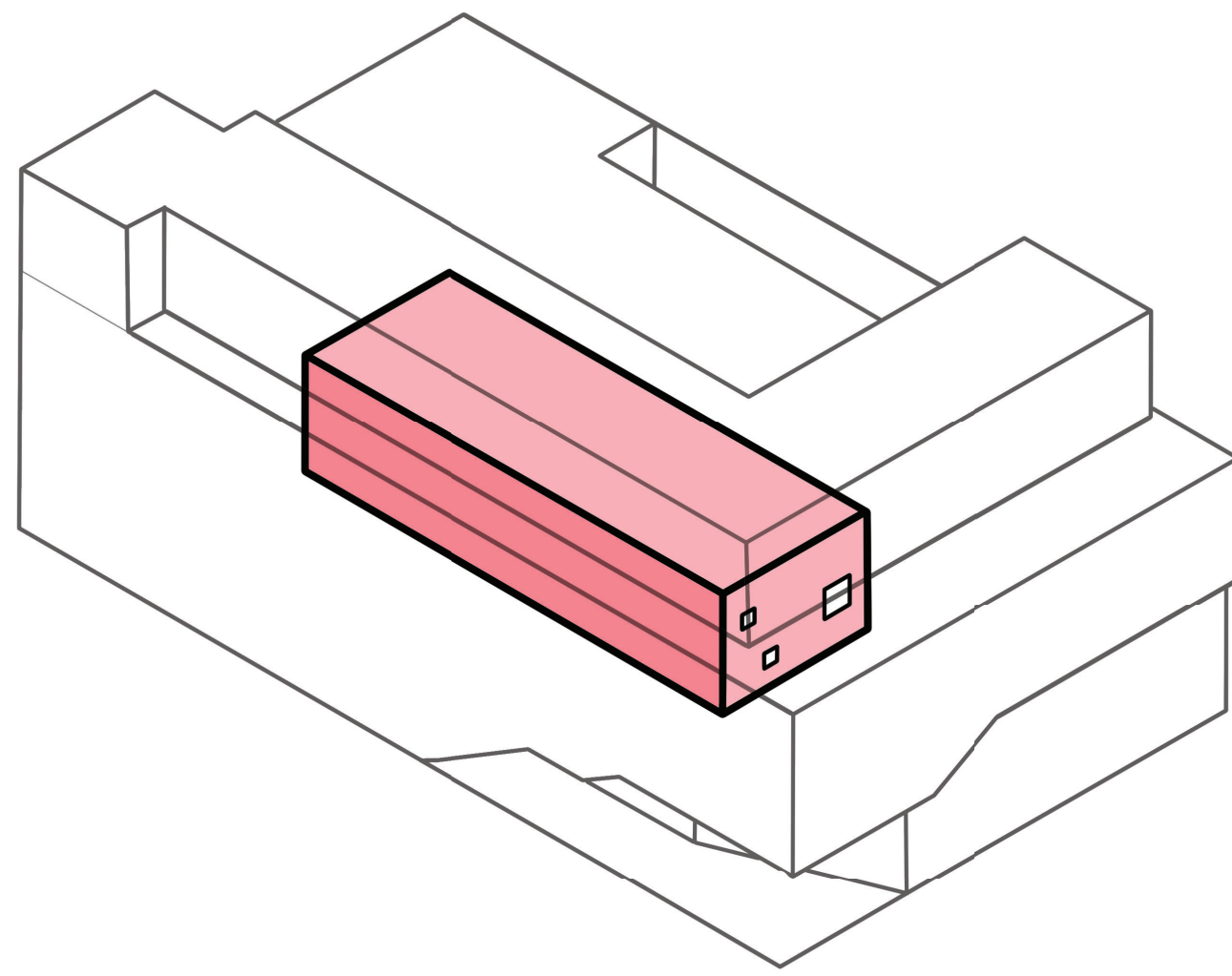

LIBRARY "JEWEL BOX"

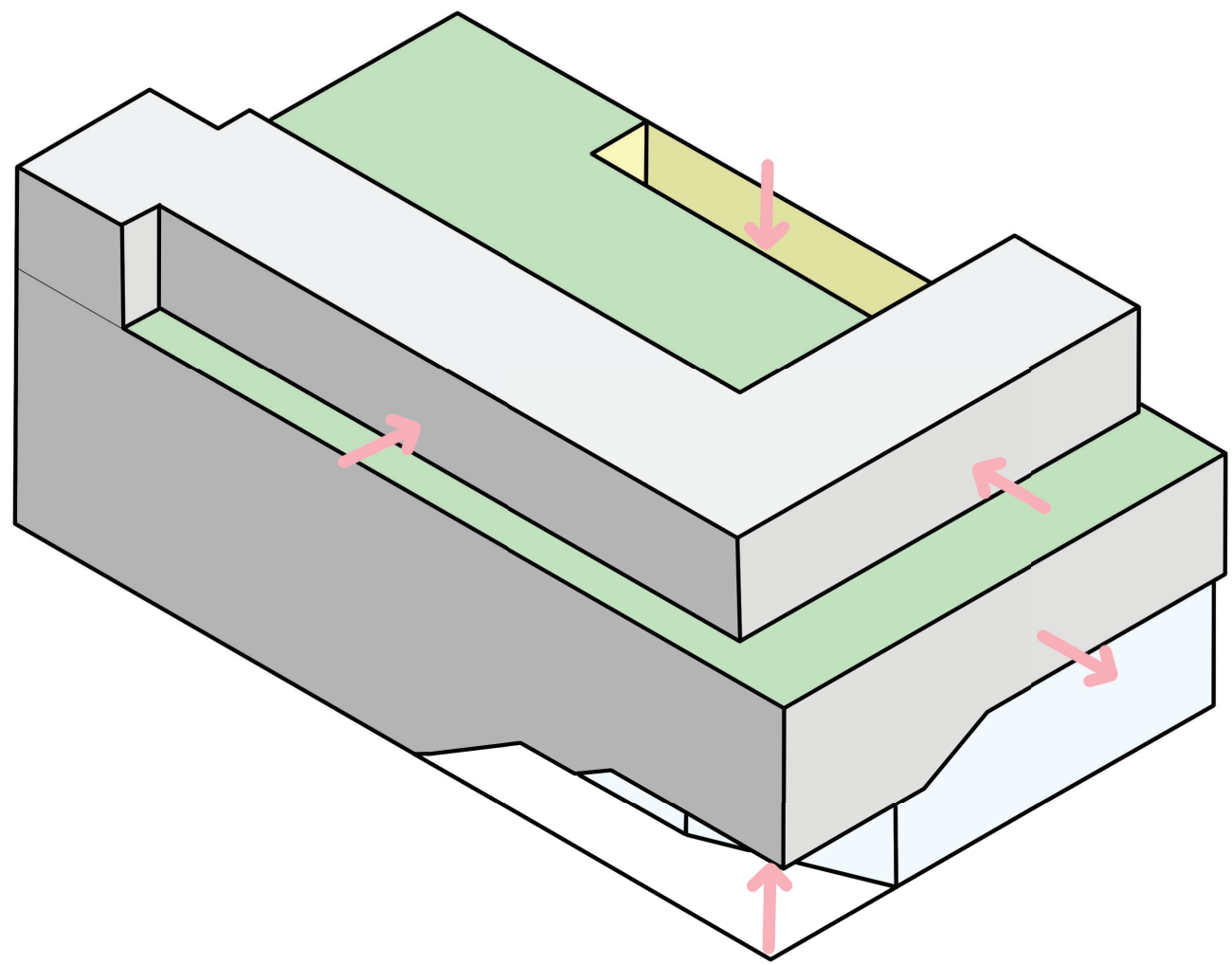

CONCEPT

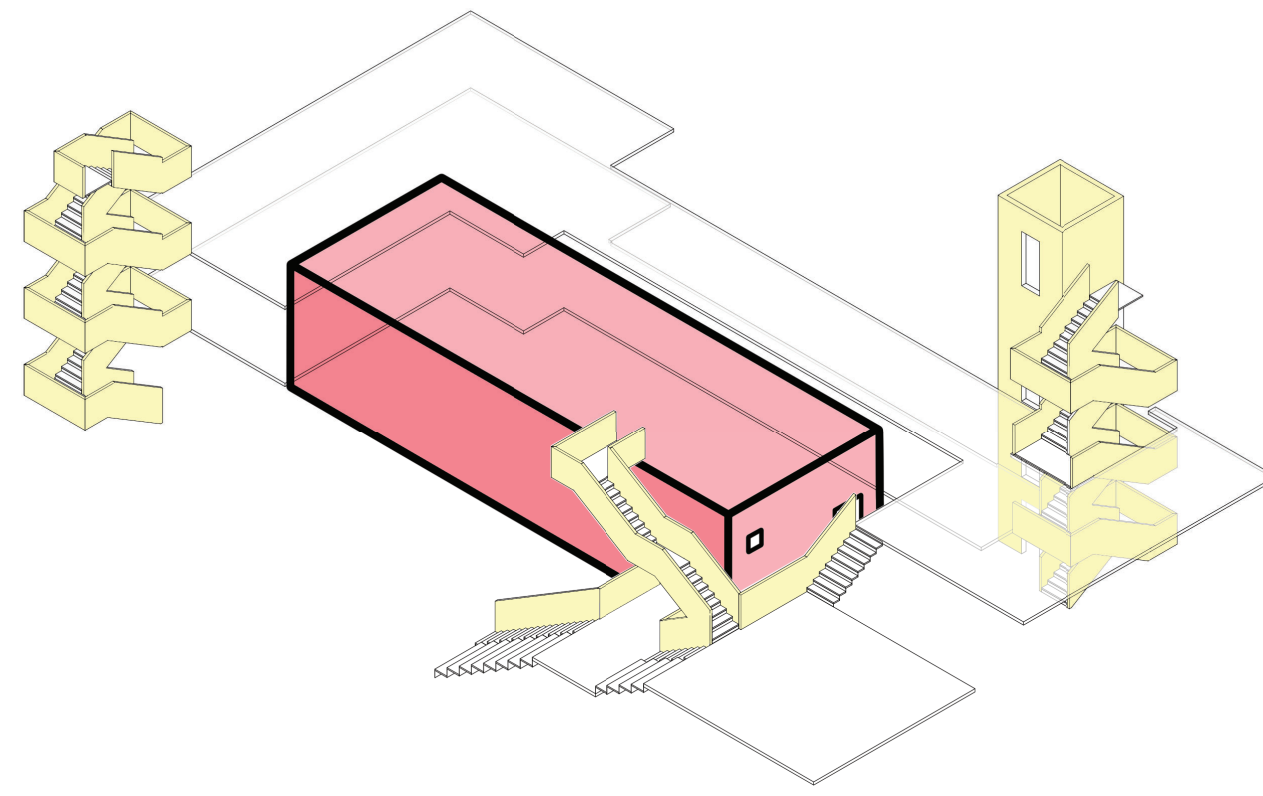

ORGANIZATION

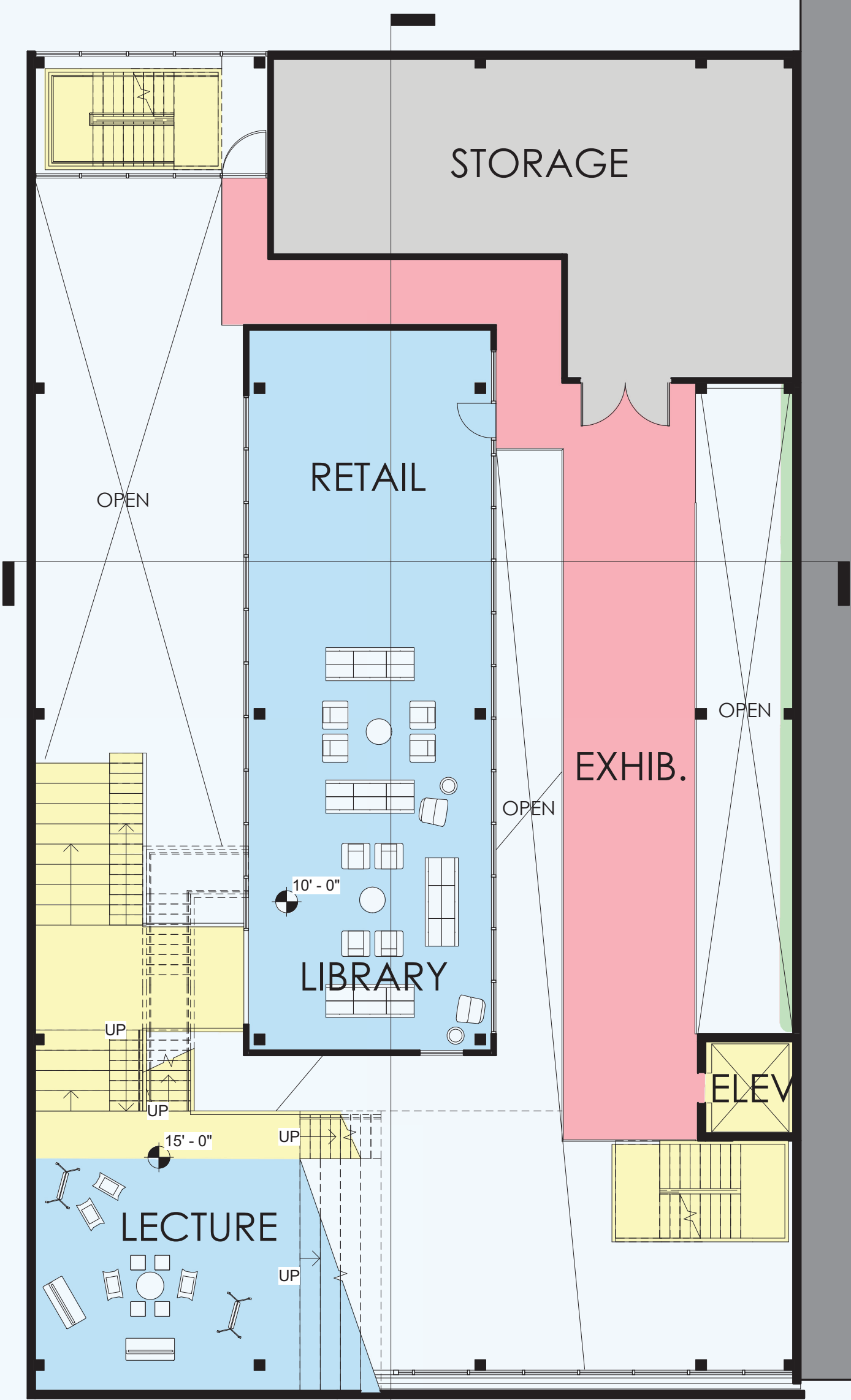

LEVEL 2.1 : 1/8" = 1'-0"

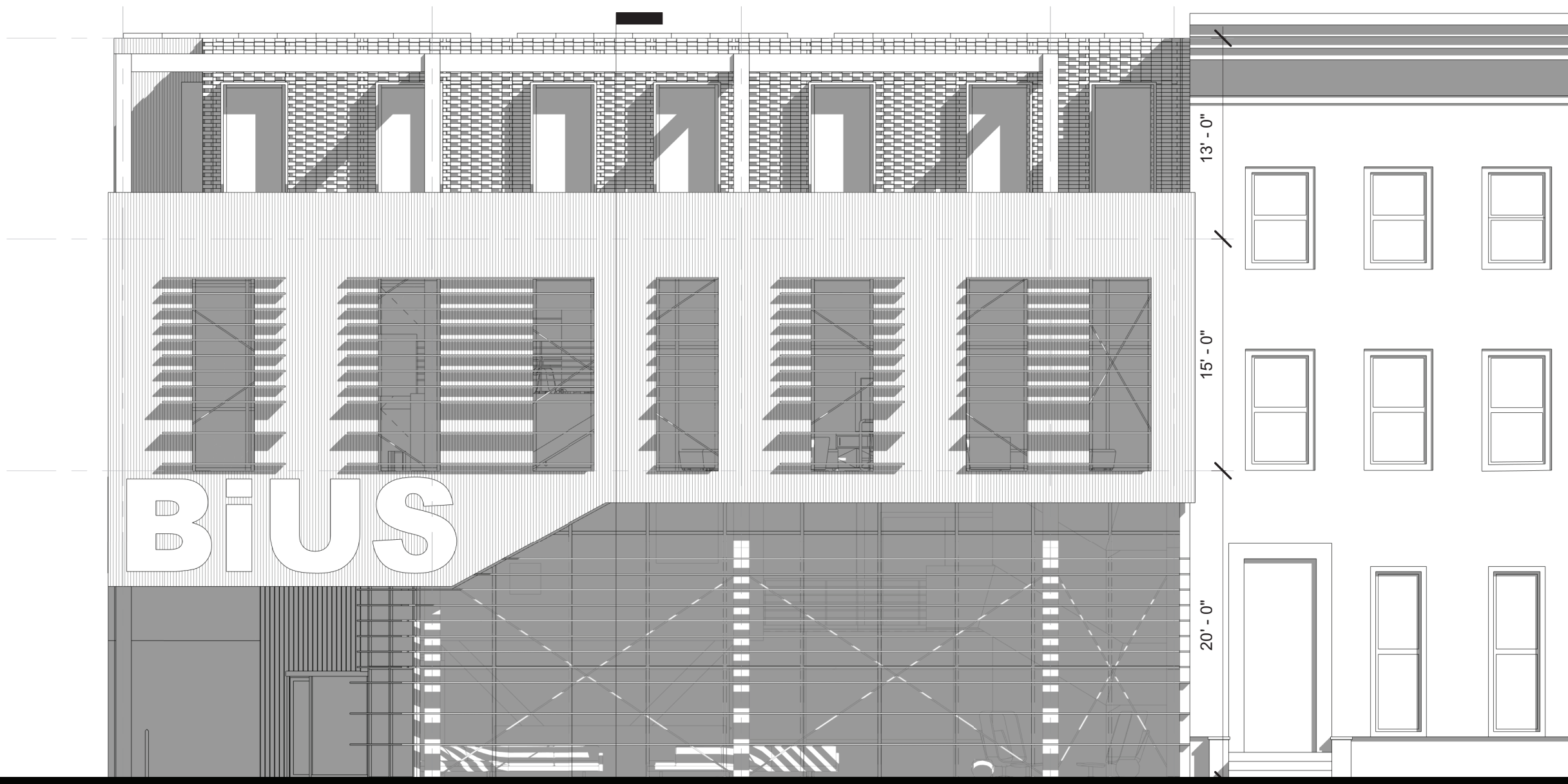

SOUTH ELEVATION : 1/8" = 1'-0"

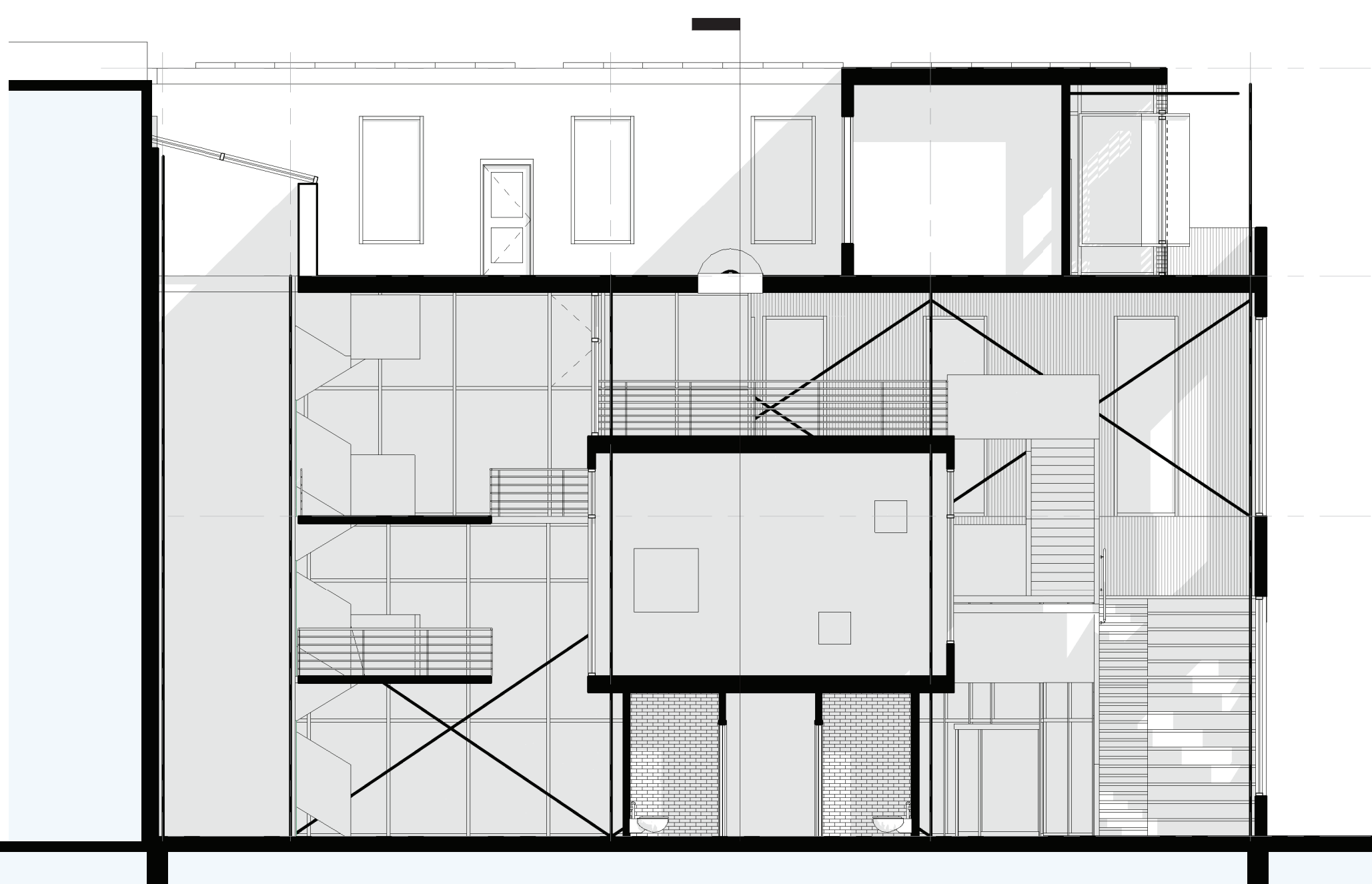

TRANSVERSE SECTION : 1/8" = 1'-0"

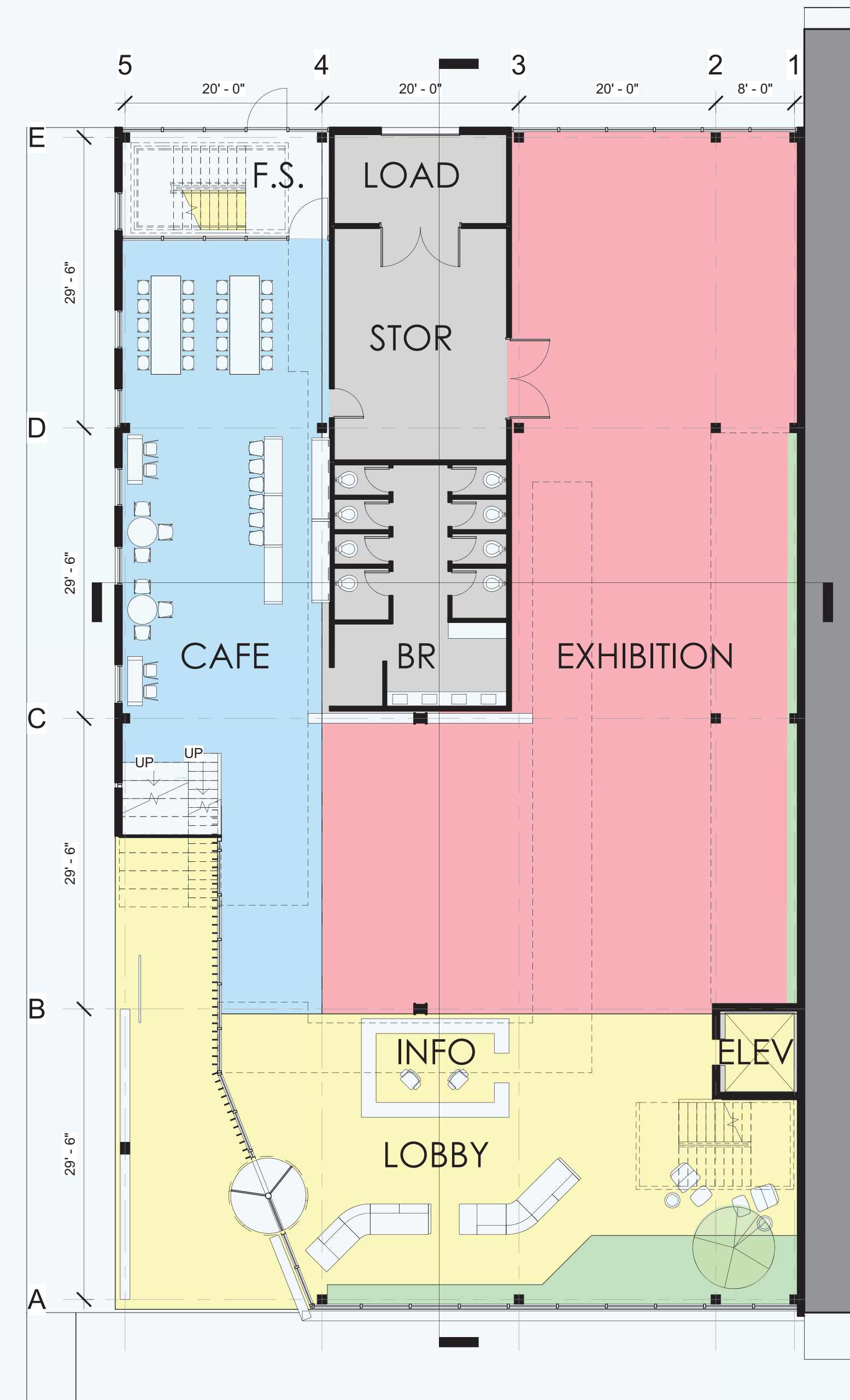

LEVEL 1 : 1/8" = 1'-0"